

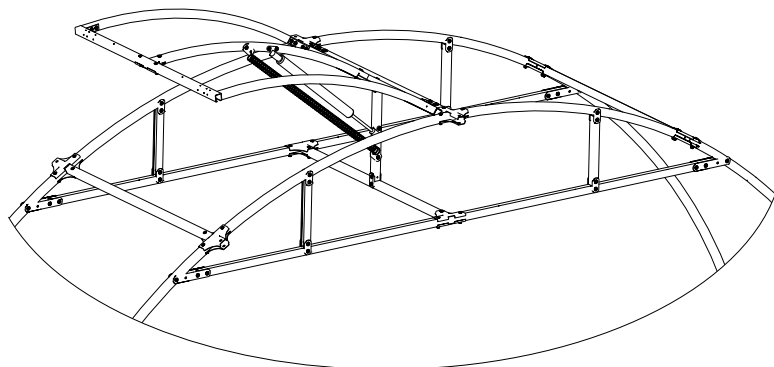









Okno do skleníku o šířce 3 m (krok mezi oblouky 0,65 m)



Specifikace

N ^o	Název profilu	Délka mm	Počet kusů
1	Oblouk	705	3
2	horizontální díly okna	626	2
3	Podélný profil krátká	642	1
4	Profil tepelného pohonu	270	1
N ^o	spojovací materiál		Počet kusů
1	plochá spojka malá 40 		6
2	panty pro zavěšení dveří a okének 		2
3	spojovací úhelník 40x40x16 		4
4	svorka trojúhelníková 		10
5	Šrouby M5x30 		12
6	matice M5 		12
7	Šrouby na kov 		32
8	Šrouby pro polykarbonátu 		30
9	Podložka s gumou 		30
10	Pružina 		1

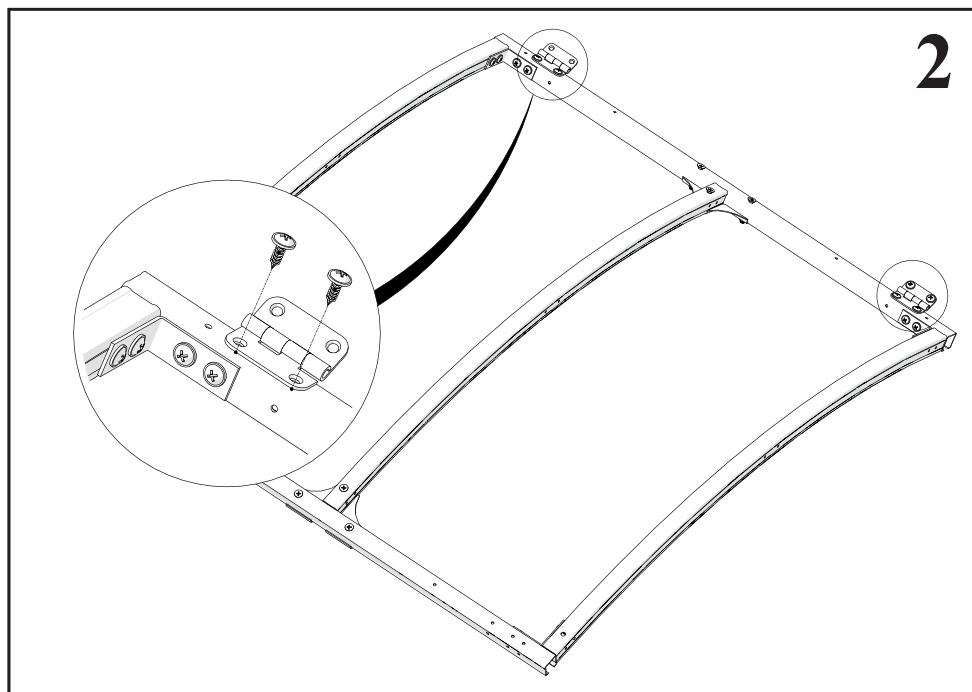
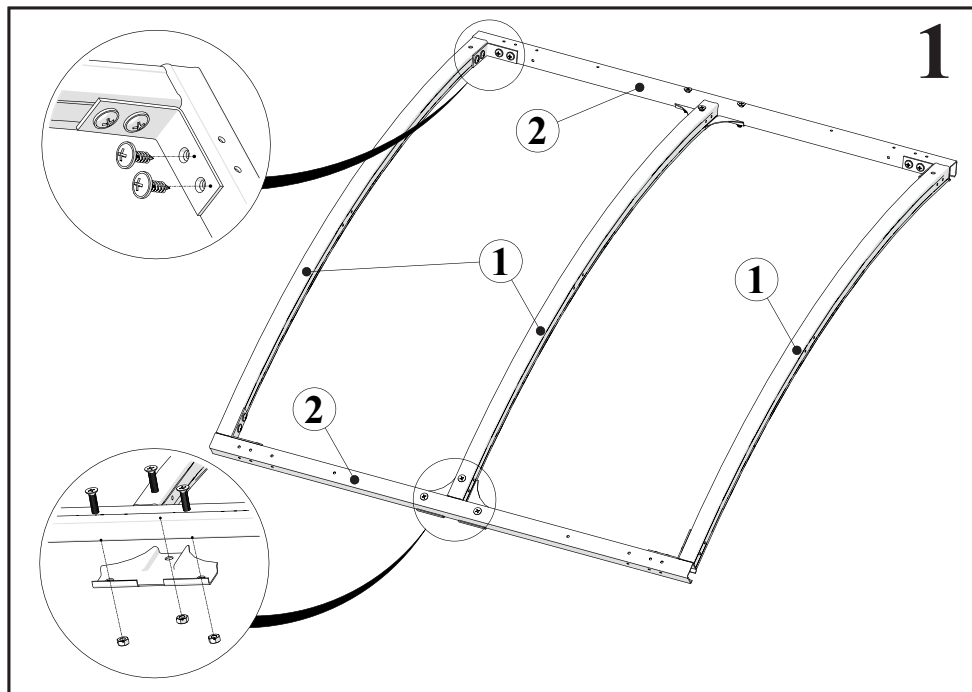

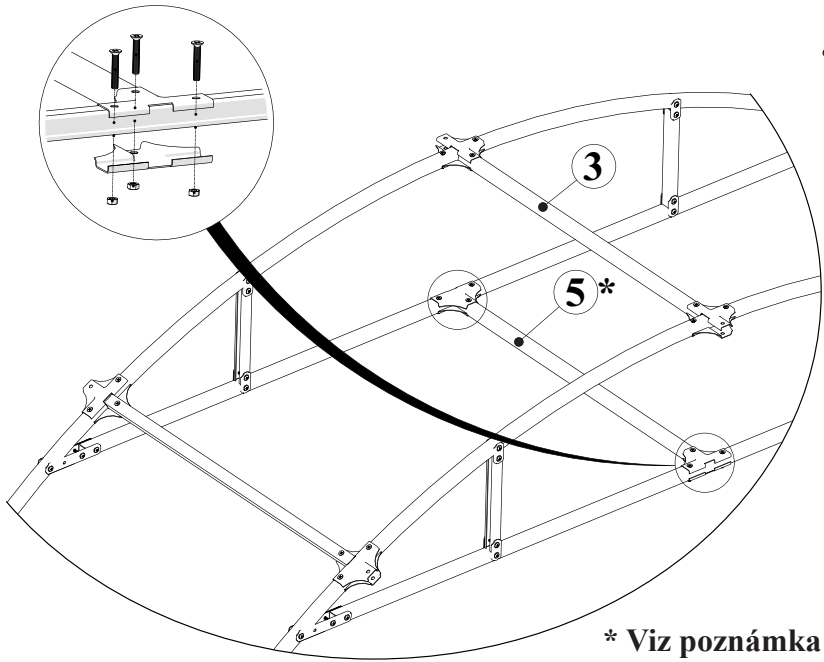
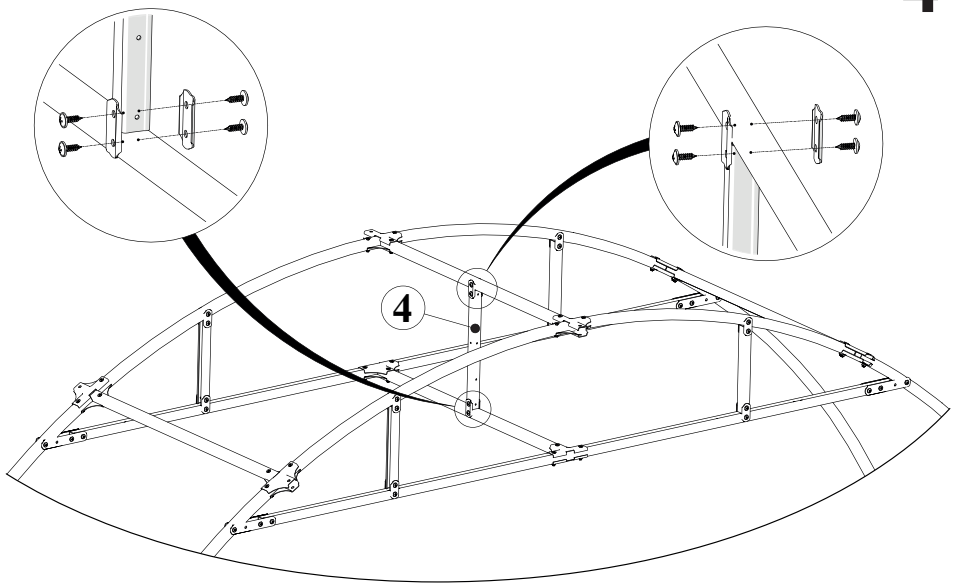
3**4**

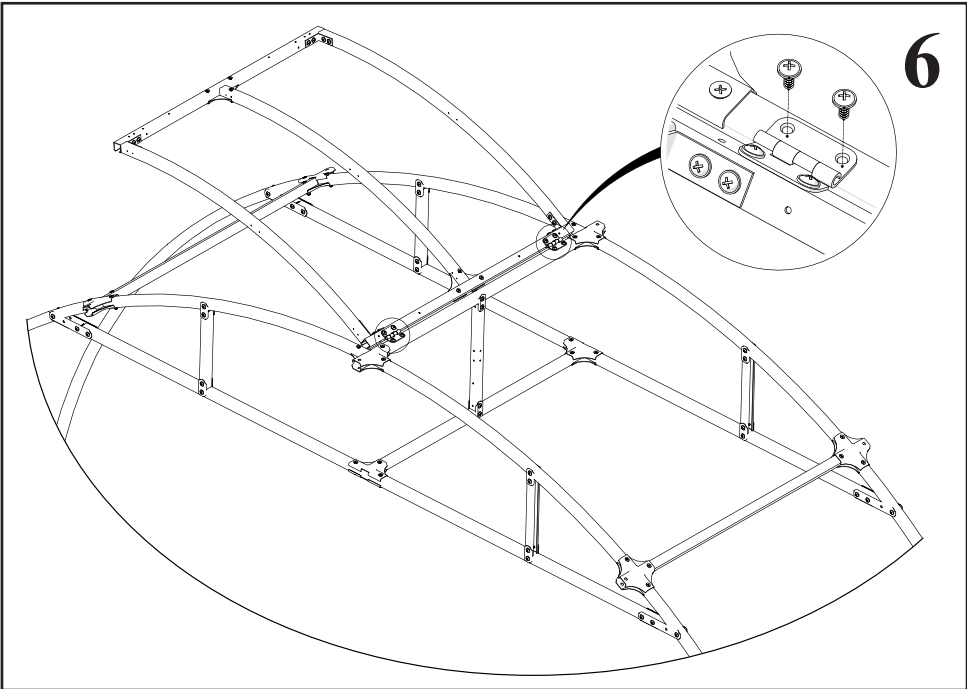
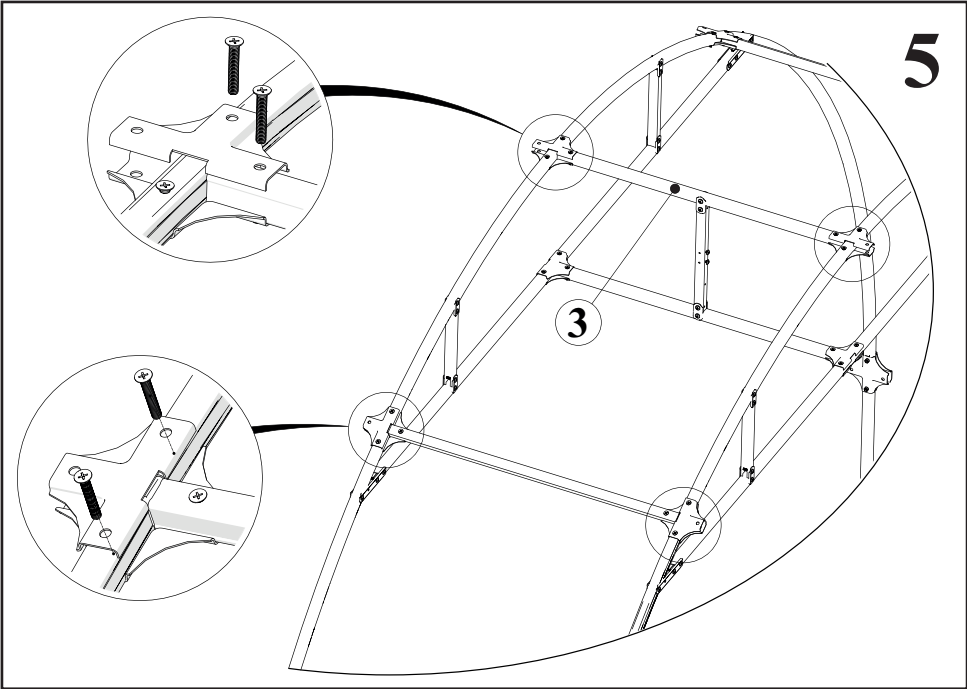

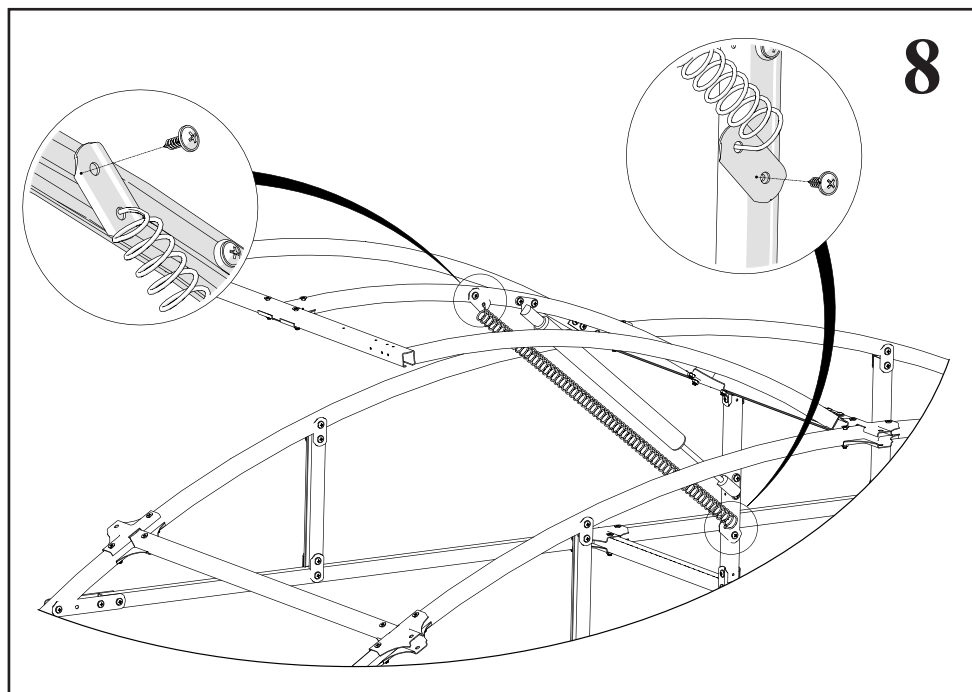
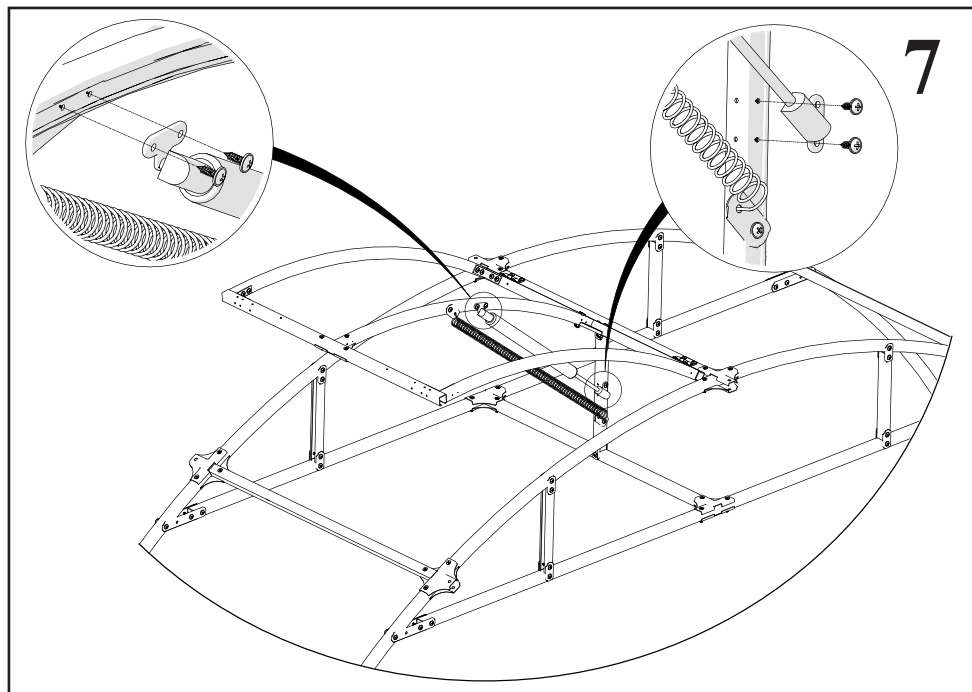

Místa upevnění polykarbonátu

9

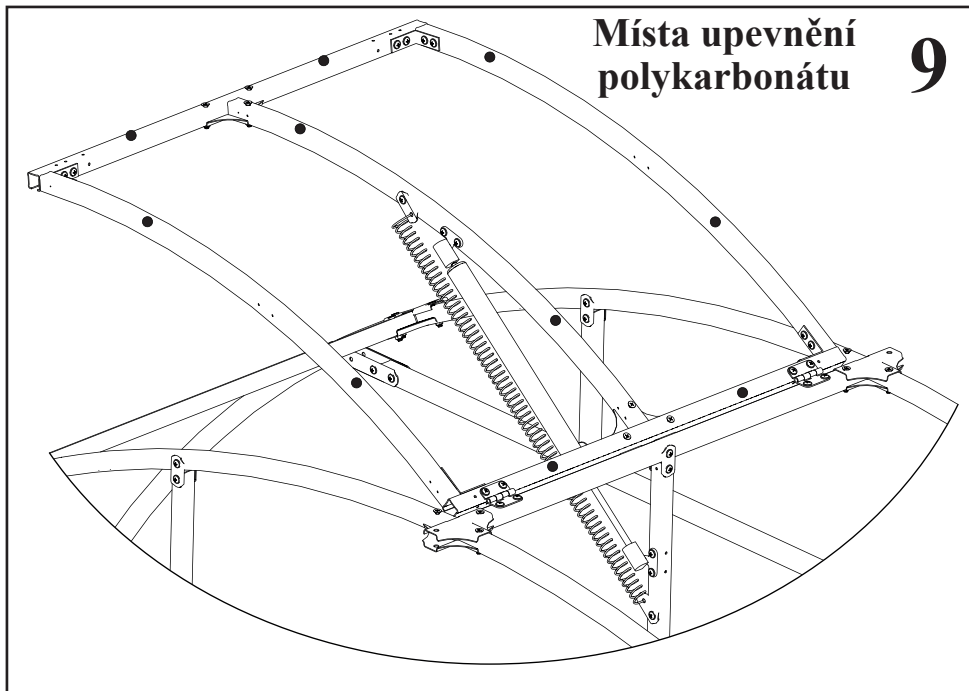

Poznámka

Ilustrace č. 3:

1. Podélný profil krátká № 5* součástí standardního skleníku o šířce 3 metry, nainstalován mezi horní výztuž s pomocí svorka trojúhelníková.

2. Podélný profil krátká (číslo profilu 3) instalován mezi oblouky skleníku.